



MADE IN FRANCE

BUILT-IN AND COMPACT WINE CABINET RANGE

A sober and elegant design to suit all interiors
The assurance of the protection for your best wines

ArteVino

ArteVino

A brand of EuroCave Group, the world reference for the ageing and service of wine. ArteVino relies on the Group's expertise in designing its wine cabinets with the highest level of requirements.

ArteVino wine cabinets recreate the best environment possible for correctly ageing your best bottles of wine.

With their elegant and modern design and their universal shelves to meet all your needs, the ArteVino wine cabinets fit perfectly into your interior to offer you a wonderful moments of testing and sharing.



Glossaire & modularity	p.4
Performance & Quality	p.5
Ageing & Serving	p.5
Built-in or stand alone	p.6
Interview	p.7
Technical data	p.8-9



ArteVino

DESIGN & MODULARITY



A design developed to fit perfectly into all interiors

- Double gazed glass door
- Sophisticated black frame
- Stainless steel handle
- LED lighting to enhance your bottles
- Soft lighting atmosphere for your interior



Personnalized the interior layout of your wine cabinet

- 4 sliding shelves made of solid beech wood
- Shelves designed to accomodate all types of bottles
- Modular shelf positioning, according to the size of the bottles.

One shelf, several uses



Storing shelf
Optimised bottle capacity



Sliding shelf
Easy access to all bottles



Presentation shelf
To highlight your best bottles

PERFORMANCE & QUALITY



Protecting your wine

ArteVino relies on the expertise of the EuroCave Group to design its wine cabinets with the highest level of requirements. Benefit from the perfect environment for correctly ageing your wine:

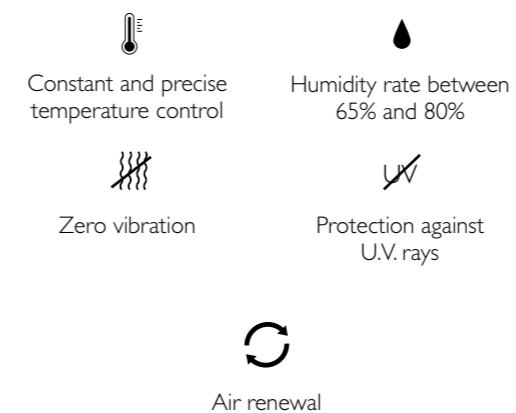

High quality materials

To ensure the best performance, ArteVino uses sustainable and high quality materials for the body and equipment of its wine cabinets. Inner walls in aluminium, reinforced insulation and wooden shelves.

5 YEARS WARRANTY

Made in France

Manufactured in Fourmies (North of France), in the Eurocave Group factory, the world expert in wine storage and serving solutions.

AGEING & SERVING

Our 1-temperature wine cabinet is dedicated to the ageing of your bottles. It ensures a constant and homogenous temperature throughout the wine cabinet, which we recommend to set the temperature at 12°C, allowing your best bottles to improve and reach their peak.

Our multi-temperature service, for serving, wine cabinet allows to store you wine bottles while keeping them at the ideal tasting temperature. The temperature gradient inside the wine cabinet allows to keep your wine at temperatures ranging between 6°C, to refresh your champagne bottles, and 20°C, for your red wines.

Suitable for wines consumed regularly or in addition to an ageing wine cabinet



BUILT IN STAND ALONE

A single wine cabinet
for two possible installations

Let your decoration desires guide you

A single wine cabinet for two different installations: built-in or stand alone.

The compact body and the elegant aesthetics of COSY, have been designed to fit perfectly into your kitchen, with a quick and easy installation. But the Cosy range will also easily find its place in your living room, while offering the best environment for serving, preserving or ageing your wine.



INTERVIEW

Meeting with the ArteVino product and industrial designer

What is the purpose of your job? At which stage of the project are you involved?

My job is about designing a new product that will meet the Marketing requirement specifications. I change an industrial equipment into an everyday life object. I work with the Marketing department and I must continually take into account the commercial and technical constraints. But I especially need to translate the identity and values of the company by respecting one of the most important criteria for the ArteVino brand : QUALITY.

I am involved in a project from the feasibility phase to the industrialisation of the final product.

What will motivates you in a new project?

To give form to an idea, look for the best technical solutions, innovate and finally have the satisfaction of discovering this new wine cabinet in store.

It is always a very special emotion!

What was the main challenge for Cosy?

Without hesitation: to develop a product with a sophisticated design, easy to use for every day life, that respects our quality criteria of quality while offering the best value for money.

If you had to choose 3 words to describe the Cosy range, which would they be?

Qualitative, aesthetic, pride

How do you balance the client expectation for their wine protection and storage and the aesthetic criteria?

Our 20 years of experience in the wine market and our belonging to the EuroCave group make us the expert in wine cabinets. Our expertise in cooling control allows us to offer products on the market that perfectly respect the essential criteria for wine preservation. The concept of aesthetics, the design of our products but also their functions are part of our requirement specifications. We are inventor, engineer and ergonomist, all at the same time!

TECHNICAL DATA

COSY I-TEMPERATURE / AGEING

Standard equipment bottle layout

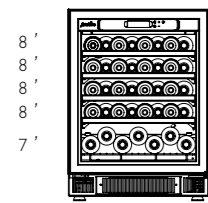

39 bottles*
sliding mode x4

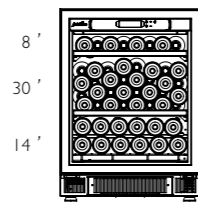

52 bottles*
sliding mode x1
storage mode x1

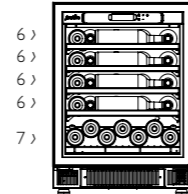

31 bottles*
sliding mode x4



Function

Single-temperature

Dimensions

Small size (HxWxD) = 818-834 x 55 x 594 mm

Cabinet temperature setting range

9°C - 15°C

Recommended room temperature range

0°C - 30°C

Type of shelf

Universal, in beech wood

Sound emission

41 dB(A)

Sound emission class

C

Feet

4 adjustable feet

Possible to adjust height

816-875 mm

Lighting

LED, white in colour

Type of door

U.V.-proofed double-glazed glass door

Visual alarms

Temperature alarm
Sensor fault alarm
Humidity fault alarm

TECHNICAL DATA

COSY MULTI-TEMPERATURE / SERVING

Standard equipment bottle layout

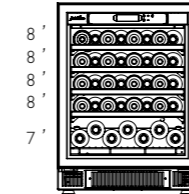

39 bottles*
sliding mode x4

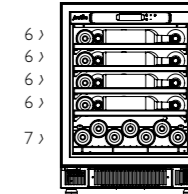

31 bottles*
sliding mode x4



Function

Multi-temperature

Dimensions

Small size (HxWxD) = 818-834 x 55 x 594 mm

Temperature gradient of the cabinet

6 - 20°C

Temperature setting range for the bottom of the cabinet

6°C - 10°C

Temperature setting range for the top of the cabinet

15°C - 20°C

Recommended room temperature range

12°C - 30°C

Type of shelf

Universal, in beech wood

Sound emission

41 dB(A)

Sound Emission class

C

Feet

4 adjustable feet

Possible to adjust height

816-875 mm

Lighting

LED, white in colour

Type of door

U.V.-proofed double-glazed glass door

Visual alarms

Temperature alarm
Sensor fault alarm
Humidity fault alarm

FLUSH-FITTING DIAGRAM

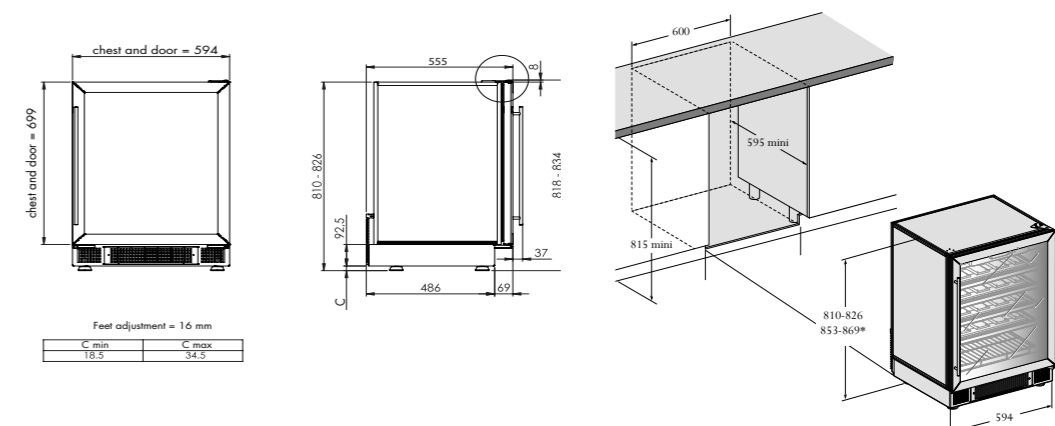

* Traditional Bordeaux bottles – hollow base.
Further details on the EPREL database. You can obtain the EPREL data sheet by contacting your EuroCave reseller.

* Traditional Bordeaux bottles – hollow base. ** With the feet raising pieces.
Further details on the EPREL database. You can obtain the EPREL data sheet by contacting your EuroCave reseller.

ArteVino



www.artevino.fr/en

Specifications subject to change without notice. – Photos for illustration only
Photo credits: Studio Guy Renaux, Imaginima, Tulcarion, Nicolas Robin.
04/2021 - EuroCave Group - 24 rue Francis de Pressensé 69628 Villeurbanne Cedex
Lyon RCS B320316995



ArteVino